

UFP
EDGE[®]

Siding. Pattern. Trim.

Premium Pattern Boards





PREMIUM PROFILED PATTERN

Finished in a variety of solid-body colors, coated with semitransparent stains, or left natural, UFP-Edge is simply the best line of siding, pattern and trim on the market.

We start with the highest-grade lumber available, free of wane and with only small, tight knots that highlight the warm characteristics of natural wood. Then we shape and mould it using processes that protect the integrity of the wood and of the finished piece, including kiln drying to minimize swelling, warping and shrinkage. We also grind our knives meticulously (and often) for near-perfect profiles without whiskers or other defects.

This attention to detail adds up to the finest siding, pattern and trim offering on the market today.

TOP BENEFITS

- All patterns manufactured to industry standards
- Lumber has small, tight knots and beautiful grain for best appearance
- Kiln Dried After Treatment (KDAT) option
- Can be treated to meet application requirements
- Color treatment available for select items and regions
- Custom pattern options



TONGUE AND GROOVE

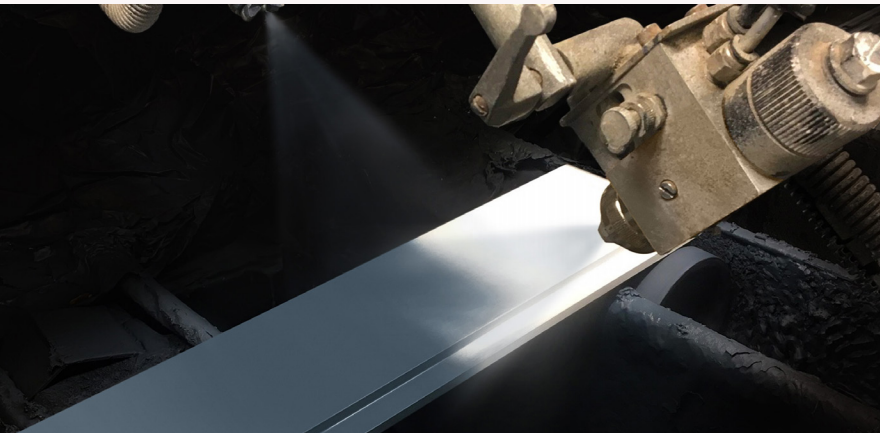

PREFINISHING

With UFP-Edge prefinished pattern, you'll get a true quality product. Our premium pattern boards are manufactured for both performance and appearance at one of our strategically located prefinishing facilities.

Our factory-applied machine coat primer covers all six sides of the board to ensure protection and long-term performance. Advanced prefinishing equipment allows us to coat a variety of substrates with unique finishes for nearly any interior or exterior application. Throughout our prefinishing process, we check for defects and quality concerns to make sure the finished surface is simply the best.



SHIPLAP



LOG TO LOG



BUTT JOINT SHIPLAP

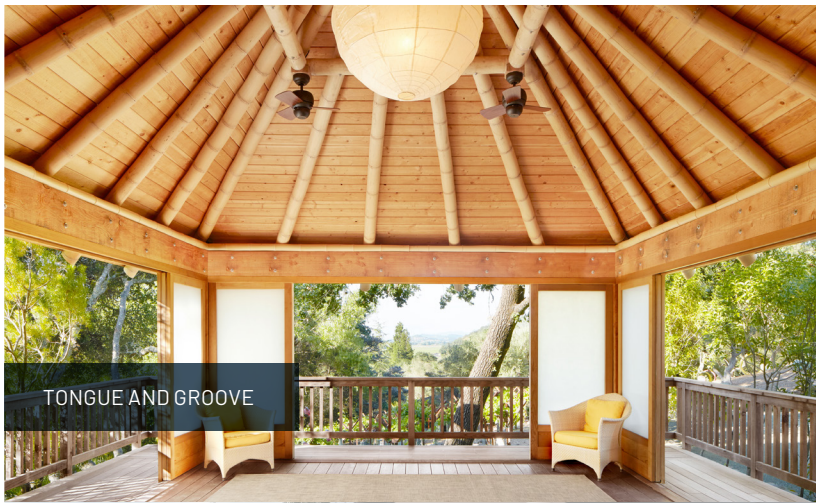

TONGUE AND GROOVE



CHANNEL RUSTIC SIDING



105 DROP SIDING



RUSTIC SHIPLAP



BOARD PATTERNS

DROP SIDING (#105)

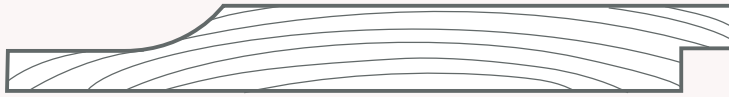

Nominal size	Actual size	Nominal size	Actual size
1 x 6	5/8" x 5 ³ / ₈ "	1 x 6	23/32" x 5 ³ / ₈ "
1 x 8	5/8" x 7 ¹ / ₈ "	1 x 8	23/32" x 7 ¹ / ₈ "

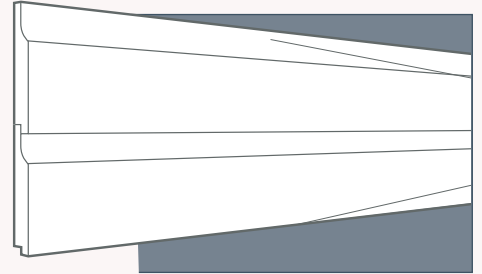

BEVELED SIDING



Nominal size	Actual size
1/2 x 6	15/32" x 6"
1/2 x 8	15/32" x 8"

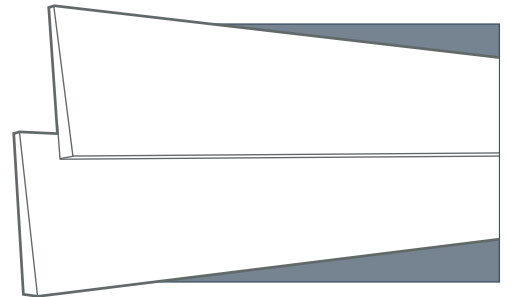

COLONIAL SIDING



Nominal size	Actual size
1 x 6	3/4" x 6"
1 x 8	3/4" x 8"

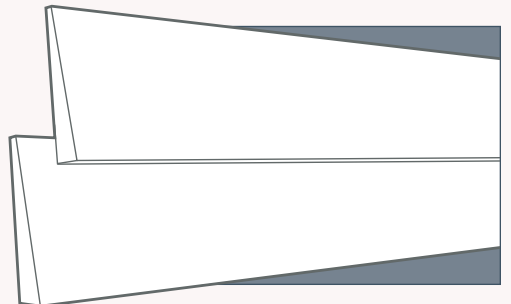

DOLLY VARDEN/TOTEM SIDING



Nominal size	Actual size	Nominal size	Actual size
1 x 6	21/32" x 6"	5/4 x 8	1 ¹ / ₄ " x 8"
1 x 8	21/32" x 8"	5/4 x 10	1 ¹ / ₄ " x 10"

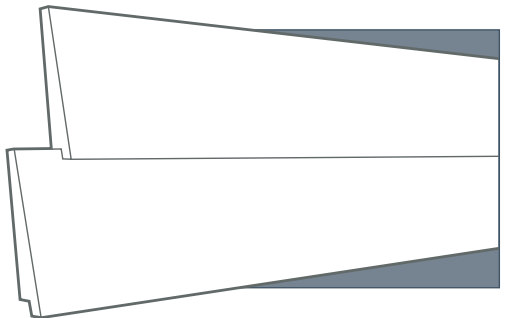

CHANNEL RUSTIC SIDING



Nominal size	Actual size
1 x 6	23/32" x 5 ³ / ₈ "
1 x 8	23/32" x 7 ¹ / ₈ "
1 x 10	23/32" x 9 ¹ / ₈ "

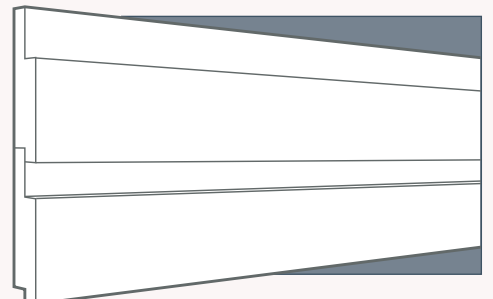

BOARD PATTERNS

LOG CABIN SIDING WITH REVEAL

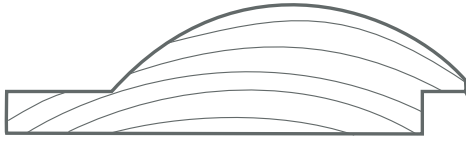

Nominal size	Actual size	Nominal size	Actual size
2 x 6	1 1/2" x 5 7/16"	2 x 10	1 1/2" x 9 1/8"
2 x 8	1 1/2" x 7 1/8"		

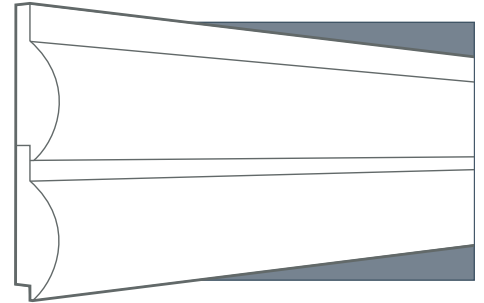

LOG CABIN SIDING

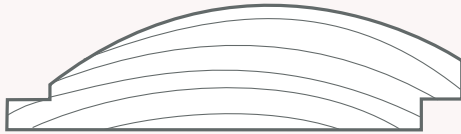

Nominal size	Actual size
2 x 6	1 1/2" x 5 7/16"
2 x 8	1 1/2" x 7 1/8"

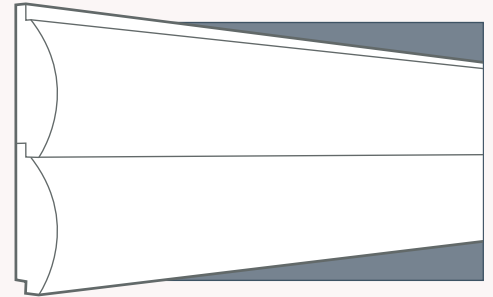

SHIPLAP BUTT JOINT REVERSIBLE

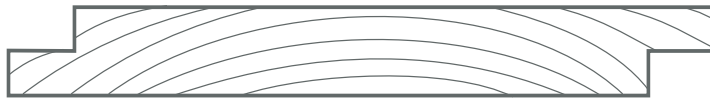

Nominal size	Actual size	Nominal size	Actual size
1 x 6	5/8" x 5 3/8"	1 x 8	23/32" x 7 1/8"
1 x 8	5/8" x 7 1/8"	2 x 6	1 1/2" x 5 7/16"
1 x 6	23/32" x 5 3/8"	2 x 8	1 1/2" x 7 1/8"

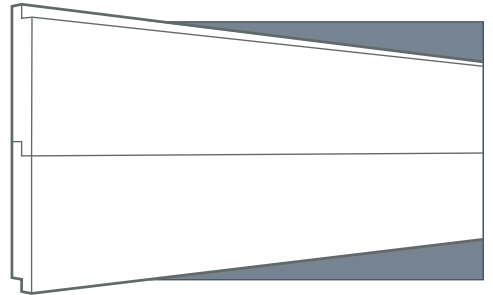

SHIPLAP NICKEL GAP

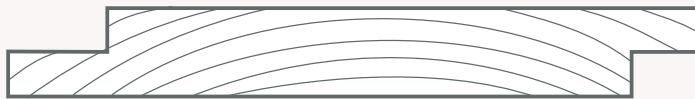

Nominal size	Actual size	Nominal size	Actual size
1 x 6	5/8" x 5 3/8"	1 x 8	23/32" x 7 1/8"
1 x 8	5/8" x 7 1/8"	2 x 6	1 1/2" x 5 7/16"
1 x 6	23/32" x 5 3/8"	2 x 8	1 1/2" x 7 1/8"

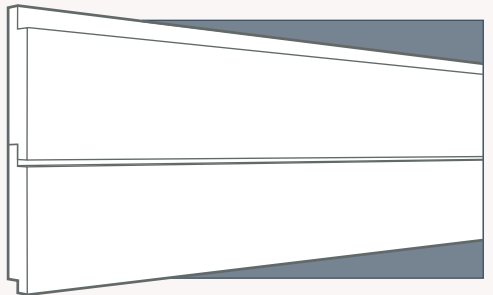

WP-11 REVERSIBLE



Nominal size	Actual size	Nominal size	Actual size
1 x 6	5/8" x 5 3/8"	1 x 6	23/32" x 5 3/8"
1 x 8	5/8" x 7 1/8"	1 x 8	23/32" x 7 1/8"

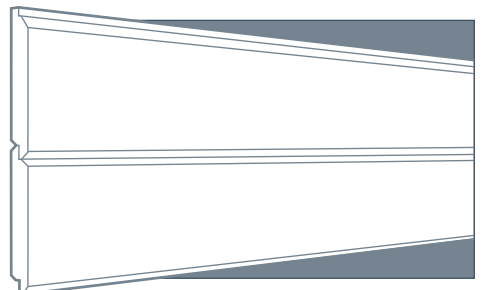



BOARD PATTERNS

V RUSTIC

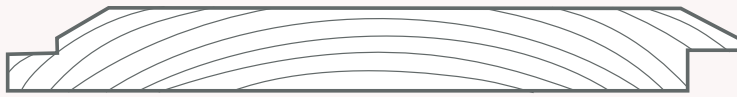

Nominal size	Actual size	Nominal size	Actual size
1 x 6	5/8" x 5 ³ / ₈ "	1 x 6	23/32" x 5 ³ / ₈ "
1 x 8	5/8" x 7 ¹ / ₈ "	1 x 8	23/32" x 7 ¹ / ₈ "

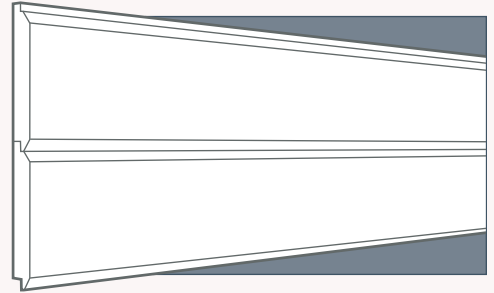

T&G BUTT JOINT/NICKEL GAP REVERSIBLE

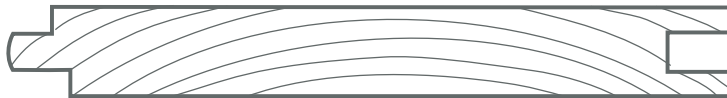

Nominal size	Actual size	Nominal size	Actual size
1 x 6	5/8" x 5 ³ / ₈ "	1 x 8	23/32" x 7 ¹ / ₈ "
1 x 8	5/8" x 7 ¹ / ₈ "	2 x 6	1 ¹ / ₂ " x 5 ⁷ / ₁₆ "
1 x 6	23/32" x 5 ³ / ₈ "	2 x 8	1 ¹ / ₂ " x 7 ¹ / ₈ "

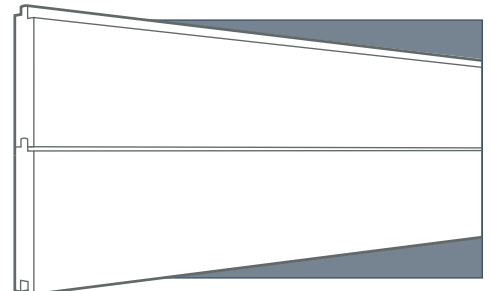

T&G BUTT JOINT



Nominal size	Actual size	Nominal size	Actual size
1 x 6	5/8" x 5 ³ / ₈ "	1 x 8	23/32" x 7 ¹ / ₈ "
1 x 8	5/8" x 7 ¹ / ₈ "	2 x 6	1 ¹ / ₂ " x 5 ⁷ / ₁₆ "
1 x 6	23/32" x 5 ³ / ₈ "	2 x 8	1 ¹ / ₂ " x 7 ¹ / ₈ "

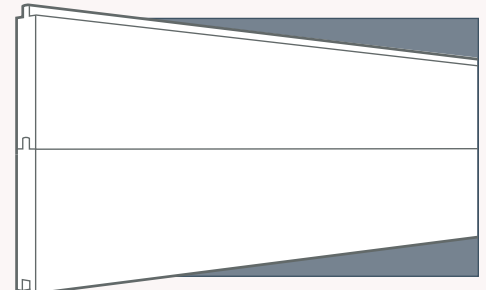

WP-4



Nominal size	Actual size	Nominal size	Actual size
1 x 6	5/8" x 5 ³ / ₈ "	1 x 8	23/32" x 7 ¹ / ₈ "
1 x 8	5/8" x 7 ¹ / ₈ "	2 x 6	1 ¹ / ₂ " x 5 ⁷ / ₁₆ "
1 x 6	23/32" x 5 ³ / ₈ "	2 x 8	1 ¹ / ₂ " x 7 ¹ / ₈ "

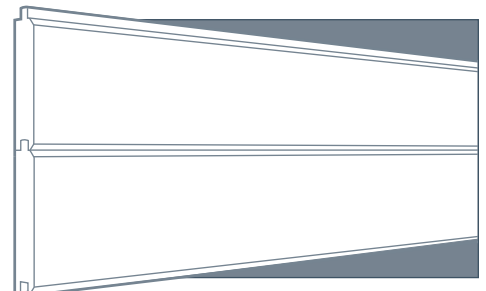

WP-4 REVERSIBLE



Nominal size	Actual size	Nominal size	Actual size
1 x 6	5/8" x 5 ³ / ₈ "	1 x 8	23/32" x 7 ¹ / ₈ "
1 x 8	5/8" x 7 ¹ / ₈ "	2 x 6	1 ¹ / ₂ " x 5 ⁷ / ₁₆ "
1 x 6	23/32" x 5 ³ / ₈ "	2 x 8	1 ¹ / ₂ " x 7 ¹ / ₈ "



BOARD PATTERNS

WP-18



Nominal size	Actual size	Nominal size	Actual size
1x6	5/8" x 5 ³ / ₈ "	1x6	23/32" x 5 ³ / ₈ "
1x8	5/8" x 7 ¹ / ₈ "	1x8	23/32" x 7 ¹ / ₈ "

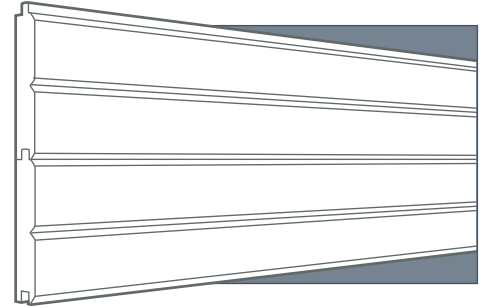

WP-4/NICKEL GAP REVERSIBLE



Nominal size	Actual size	Nominal size	Actual size
1x6	5/8" x 5 ³ / ₈ "	1x6	23/32" x 5 ³ / ₈ "
1x8	5/8" x 7 ¹ / ₈ "	1x8	23/32" x 7 ¹ / ₈ "

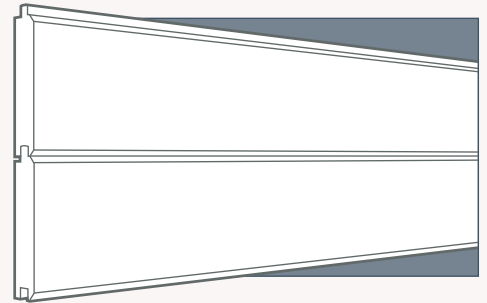

WP-4/WP-18 REVERSIBLE

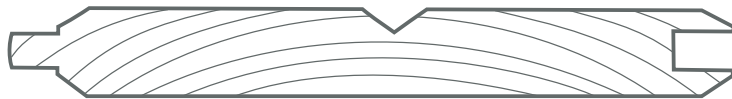

Nominal size	Actual size	Nominal size	Actual size
1x6	5/8" x 5 ³ / ₈ "	1x6	23/32" x 5 ³ / ₈ "
1x8	5/8" x 7 ¹ / ₈ "	1x8	23/32" x 7 ¹ / ₈ "

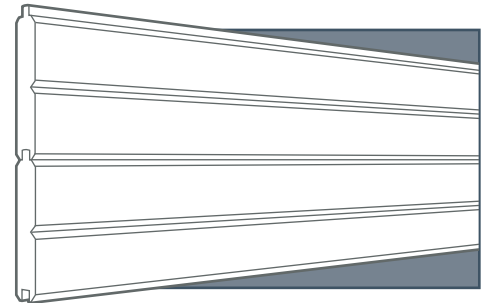

Beaded Ceiling

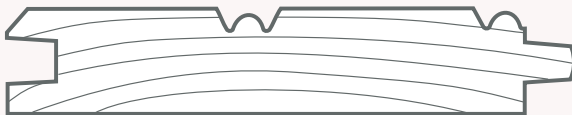

Nominal size	Actual size
1x4	5/8" x 3.5"
1x4	23/32" x 3.5"

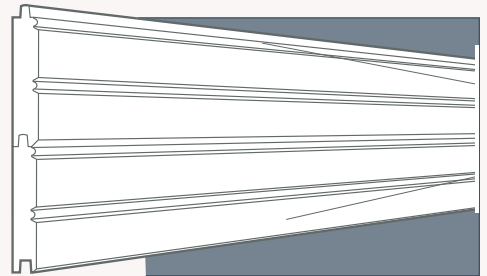

SURFACE OPTIONS



SMOOTH

ROUGH SAWN

COMBED

AVAILABLE SPECIES



SOUTHERN
YELLOW PINE

SPRUCE
PINE FIR

DOUGLAS
FIR

CEDAR

CYPRESS

WHITE FIR

Other species available by request.

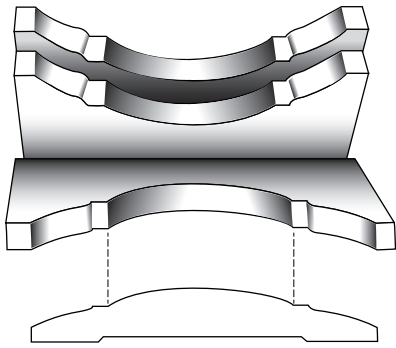

CUSTOM PROFILES

We cut our own knives and can make any profile imaginable. This also ensures accuracy and the highest quality possible because we can sharpen our knives quickly.

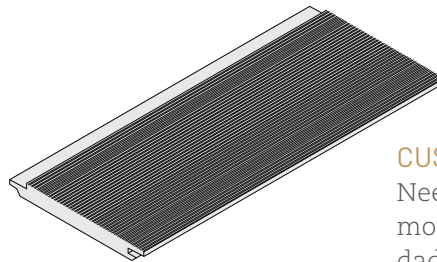
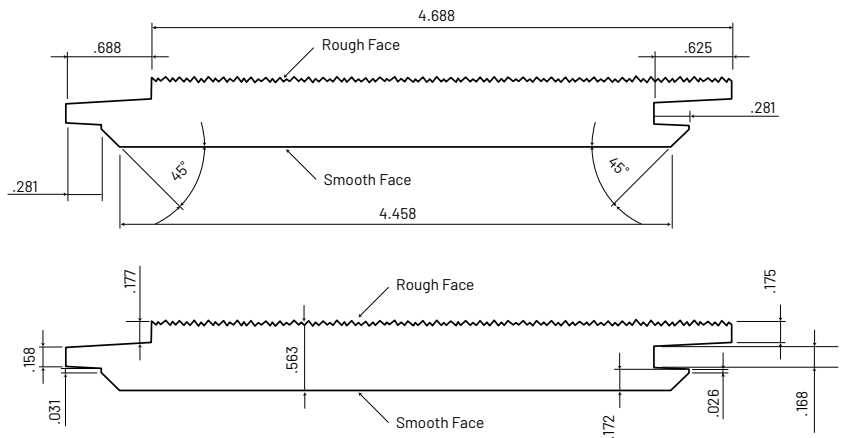

CUSTOM REVERSIBLE PATTERN

Need a custom pattern, brick mould, window sill, rain screen, dadoed fascia? We can do that.

PRIMED TRIM AND FASCIA

If you're looking for a great finish, start your project with UFP-Edge primed trim and fascia. UFP-Edge factory-applied machine coat primer covers all six sides of the board to ensure protection from the elements and long-term performance. Ask your rep for more details.

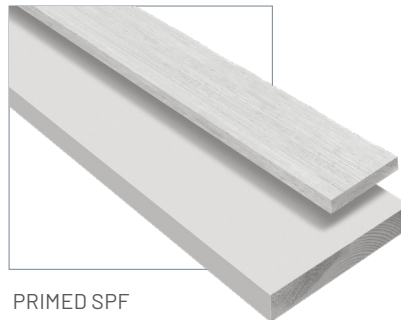

PRIMED SPF

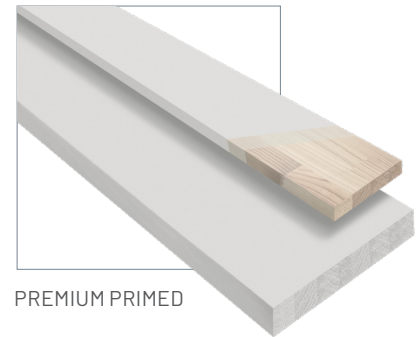

PREMIUM PRIMED



2801 East Beltline NE | Grand Rapids, MI 49525 | 1.800.598.9663

ufpEDGE.com

UFP Edge is a registered trademark of UFP Retail Solutions

©2023 UFP Industries, Inc. All rights reserved.

11274 04/23

